

# 4. FOLD EN FIGUR



Du skal bruge:

Saks



Arbejdsark:

46	47	48	49
50	51		

Kontext 3A · Kopmappe · Bestillingsnr.: 9024303 · © forlag Malling Beck

## Fra flade-figur til foldet figur

Undersøg tegningerne af de foldede figurer på arbejdsark 49.

Tegn de flade-figurerne, som passer til.

Flade-figur

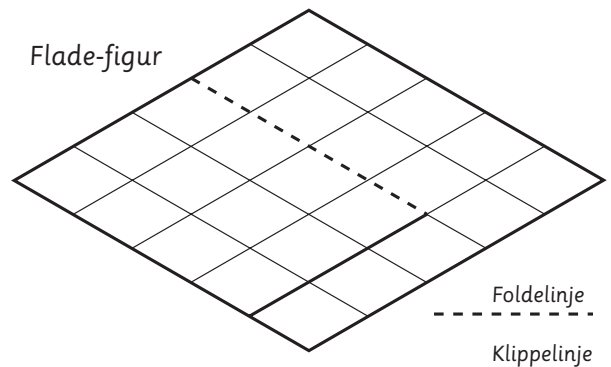

## Hvilke figurer passer sammen?

Hvilke flade-figurer og foldede figurer hører sammen?

Undersøg figurerne på arbejdsark 46 - 48

Brug arbejdsark 51 eller serviceark 144 til hjælp.

Foldet figur

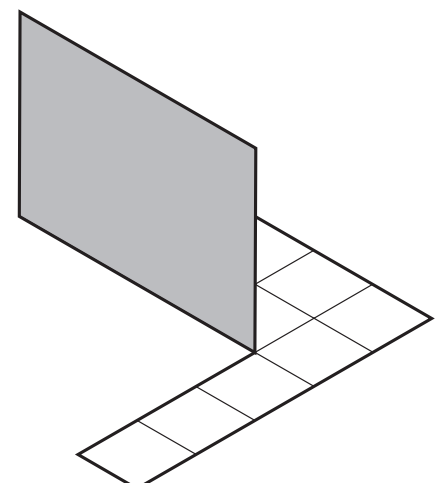

## Dine egne flade-figurer

Tegn flade-figurer til anden. Lad ham bygge dem.

Brug arbejdsark 51 eller serviceark 144 til hjælp.



# 4. Fold en figur

Tegn de flade-figurer, som passer til de fem foldede figurer.  
 Brug arbejdsark 51 til hjælp.  
 Farv foldelinjen og klippelinjen i hver sin farve.  
 Klip figuren og fold den, så den passer til tegningen.

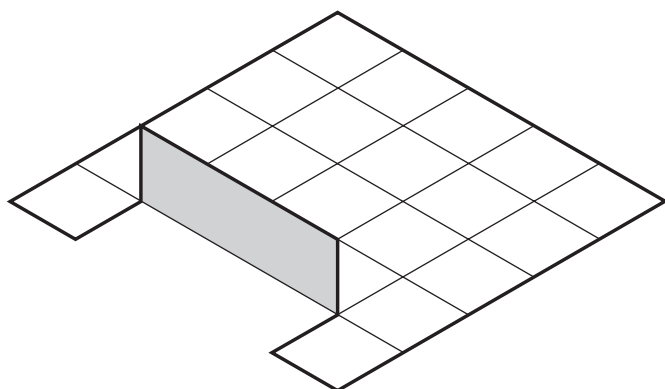
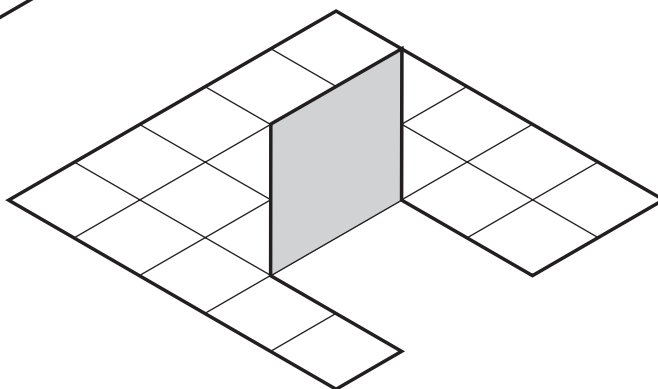
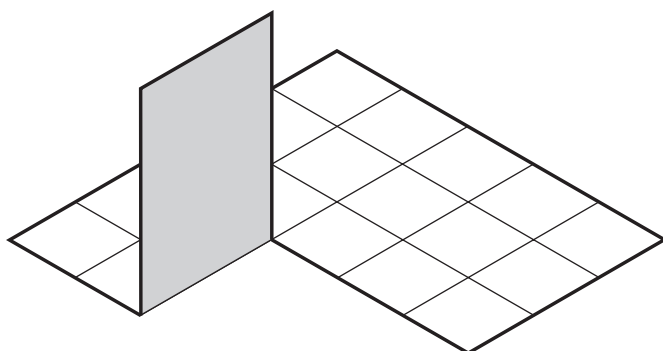
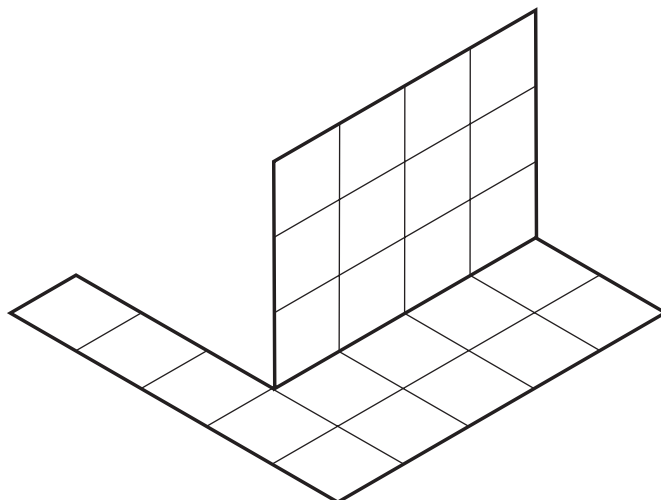
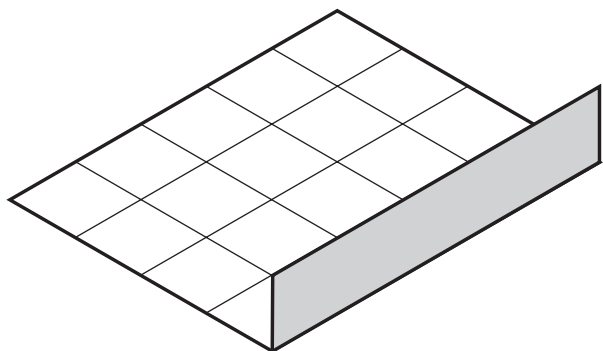

Kontext 3A · Kopmappe · Bestillingsnr.: 9024303 · © forlag Malling Beck

# 4. Fold en figur

**1** Hvilke flade figurer og foldede figurer hører sammen?  
Byg figurerne. Brug arbejdsark 51 eller serviceark 144 til hjælp.

- - - - - Foldelinje  
 \_\_\_\_\_ Klippelinje

**2** Udfyld skemaet med bogstaver.

1	2	3	4	5

Kontext 3A · Kopmappe · Bestillingsnr.: 9024303 · © forlag Malling Beck



# 4. Fold en figur

**1** Hvilke flade figurer og foldede figurer hører sammen?  
Byg figurerne. Brug arbejdsark 51 eller serviceark 144 til hjælp.

**2** Udfyld skemaet med bogstaver.

1	2	3	4	5



# 4. Fold en figur

**1** Hvilke flade figurer og foldede figurer hører sammen?  
Byg figurerne. Brug arbejdsark 51 eller serviceark 144 til hjælp.

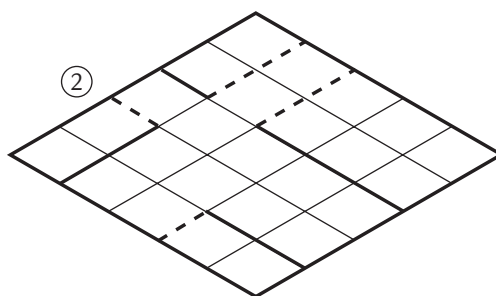
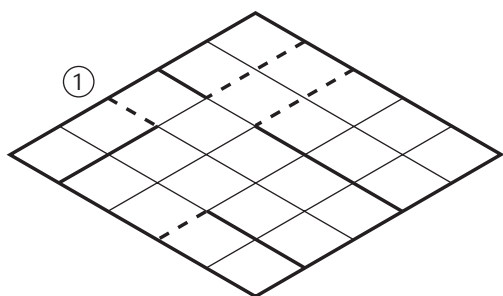

----- Foldelinje  
 \_\_\_\_\_ Klippelinje

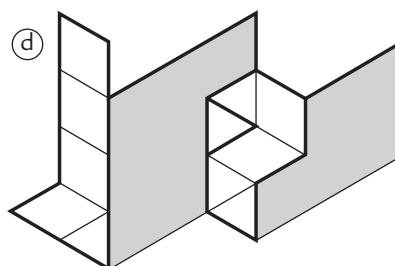
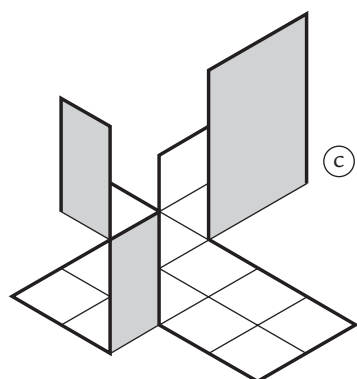
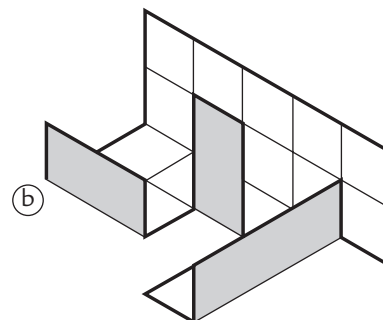
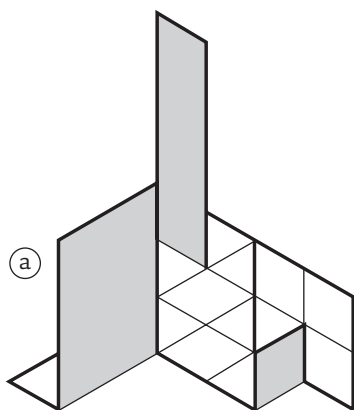
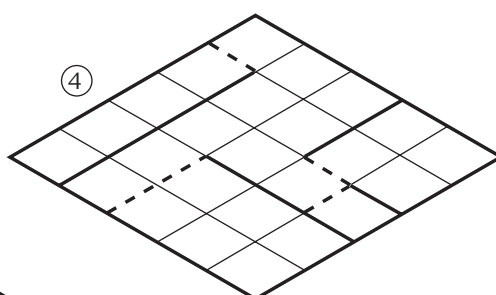
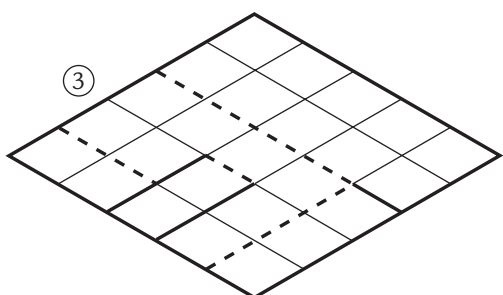

**2** Udfyld skemaet med bogstaver.

1	2	3	4

Kontext 3A · Kopmappe · Bestillingsnr.: 9024303 · © forlag Malling Beck

## 4. Fold en figur

50

- 1 Tegn flade-figurer til en anden. Lad den anden bygge, det du har tegnet. Brug arbejdsark 51 eller rhombepapir på serviceark 144.

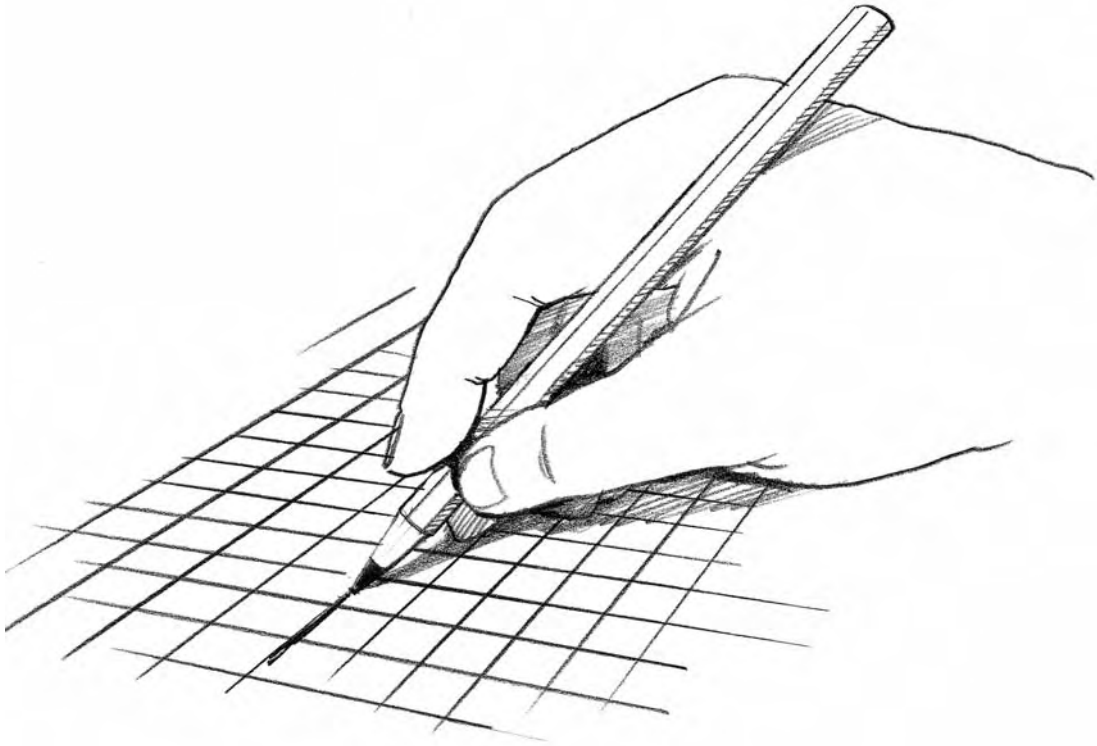

- 2 Du kan lave større flade-figurerne ved at bruge kvadrattapir i forskellige størrelser på rhombepapir. Se serviceark 144.

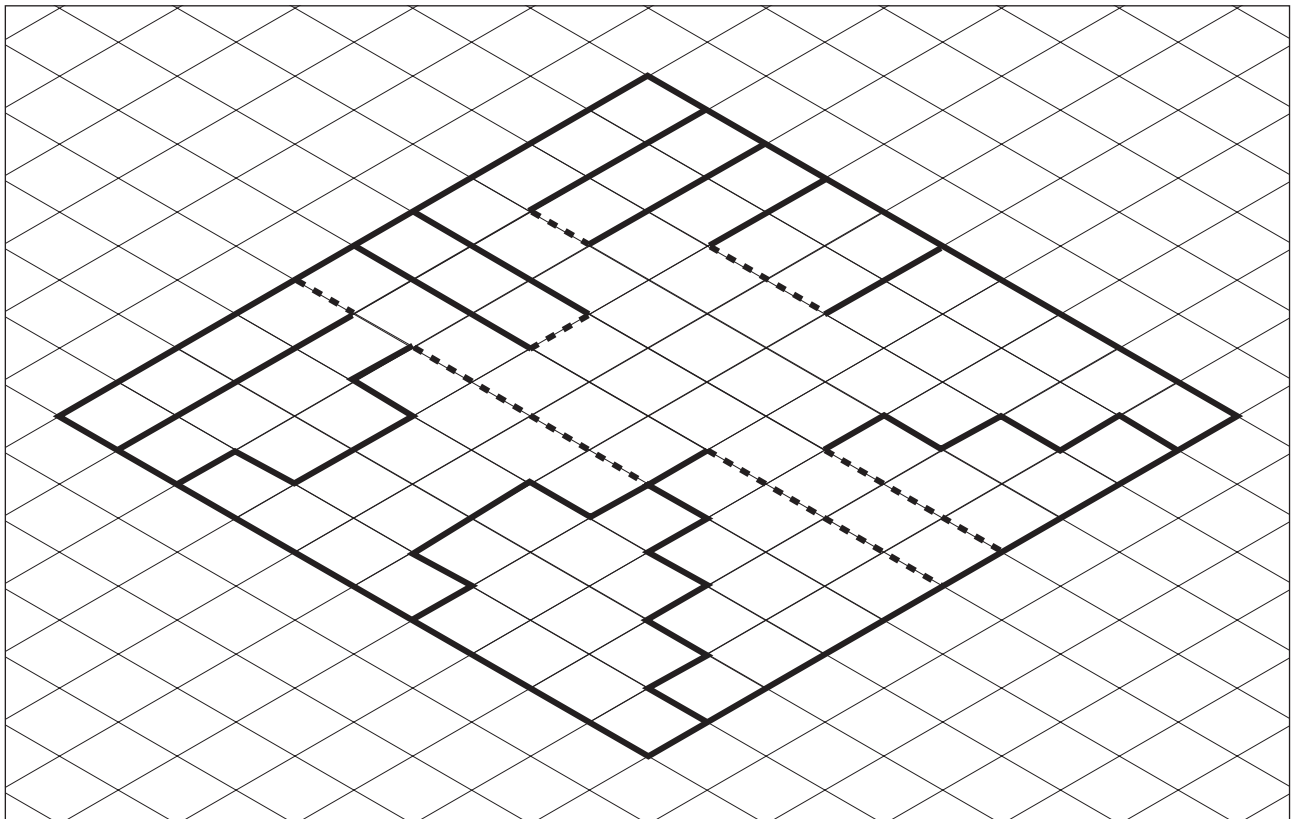



# 4. Fold en figur

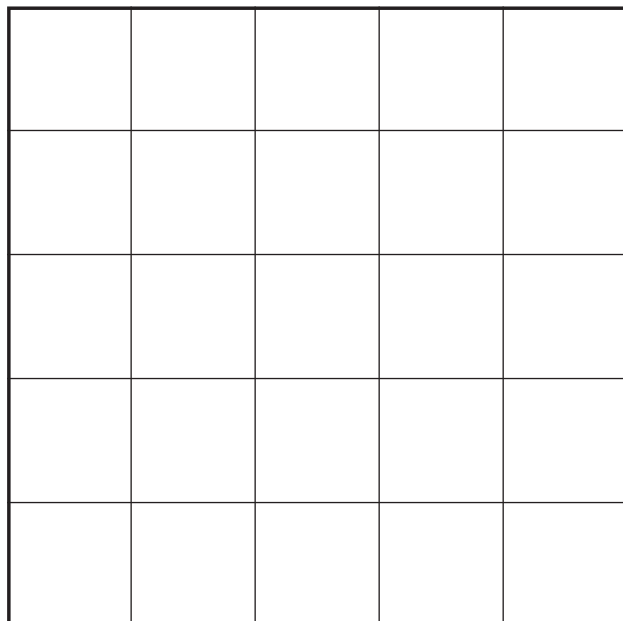
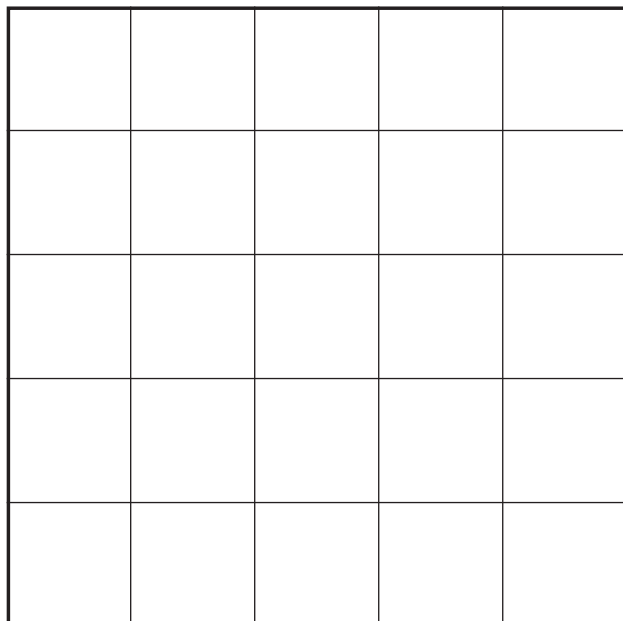
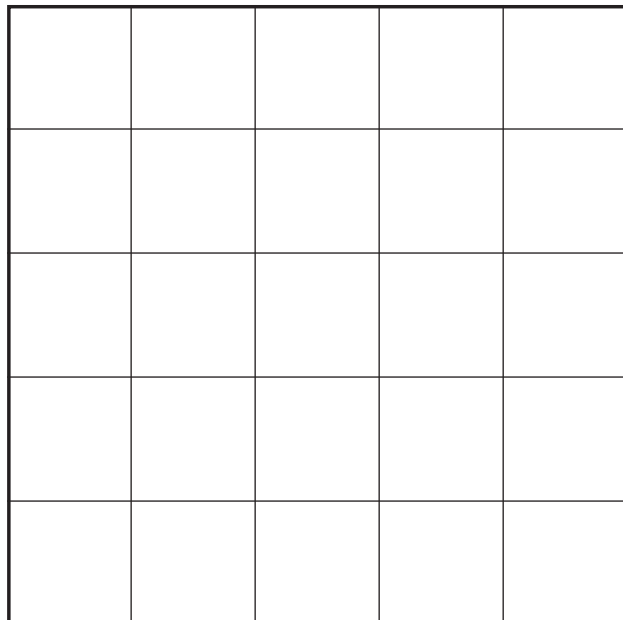
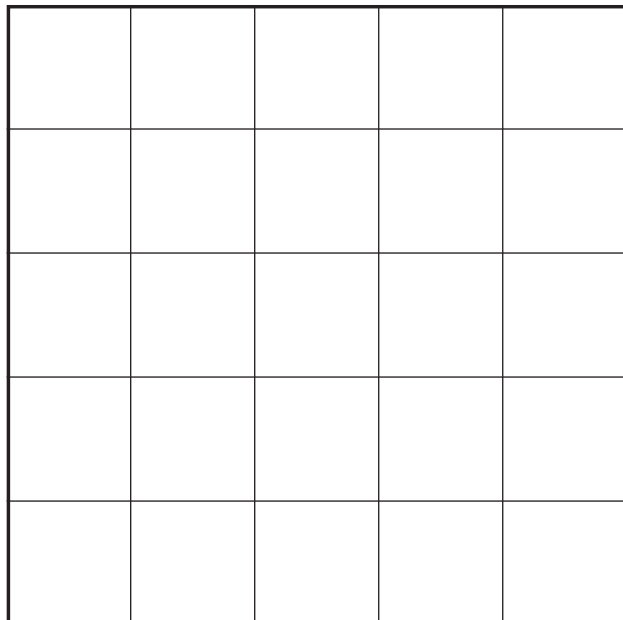

Kontext 3A · Kopmappe · Bestillingsnr.: 9024303 · © forlag Malling Beck