

Elefanterne Kæmpe og Pjok

Kopiark 17

TIL OPGAVE 4

Alder	Vægt	Afrundet vægt	Højde	Afrundet højde
0 år	121 kg	120 kg	0,92 m	0,9 m
$\frac{1}{2}$ år	415 kg		1,28 m	1,3 m
$1 \frac{1}{2}$ år	1119 kg	1120 kg	1,44 m	
2 år	1858 kg		1,7 m	
$2 \frac{1}{2}$ år	2790 kg		1,89 m	
3 år	3568 kg		2,22 m	
$3 \frac{1}{2}$ år	4621 kg		2,41 m	
4 år	4997 kg		2,77 m	
$4 \frac{1}{2}$ år	5790 kg		3,05 m	
5 år	6109 kg		3,17 m	

Papirflyver

Kopiark 18

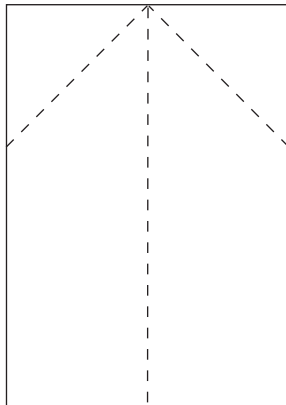

1. Fold et A4 papir på midten.

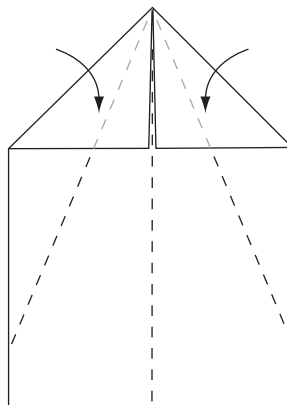

2. Fold hjørnerne ind mod midten.

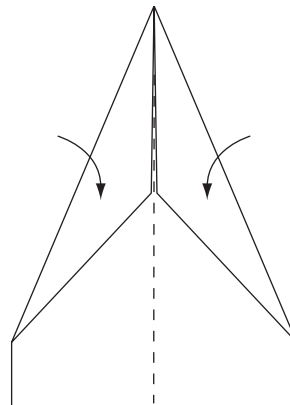

3. Fold de nye hjørner ind mod midten.

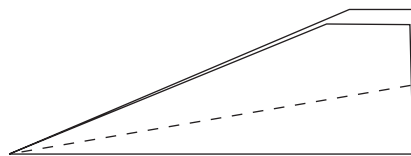

4. Fold flyet sammen på midten.

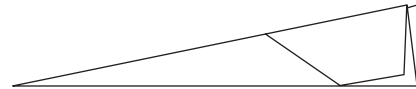

5. Fold vingerne ned til siden.
Nu er flyveren klar til at blive afprøvet.

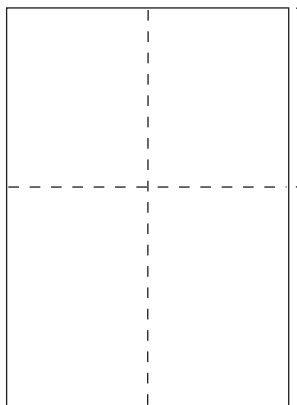

1. Fold et A4 papir som vist på tegningen.

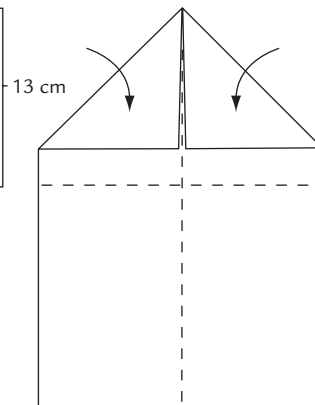

2. Fold de øverste hjørner ind mod midten.

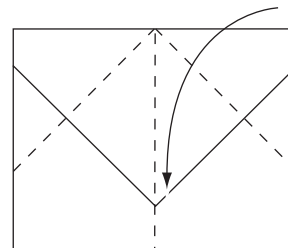

3. Fold den øverste del ned mod midten.

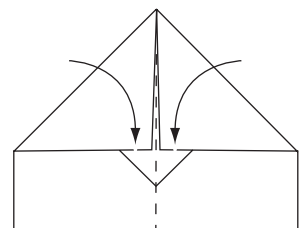

4. Fold de nye hjørner foroven ind mod midten.

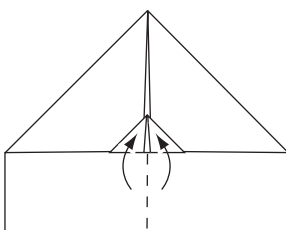

5. Fold den lille flap op og fold flyveren sammen på midten.

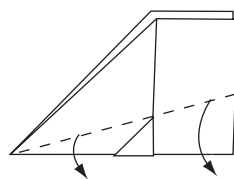

6. Fold siderne ned.

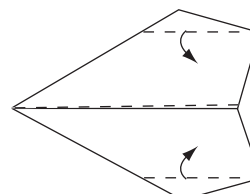

7. Fold vingspidserne opad.

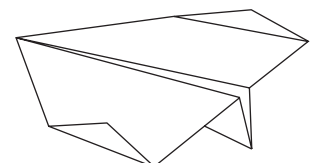

8. Nu er flyveren klar til at blive afprøvet.

